

Instructions For Use

Allegra 64R

Compact Centrifuge

For *In Vitro* Diagnostic Use

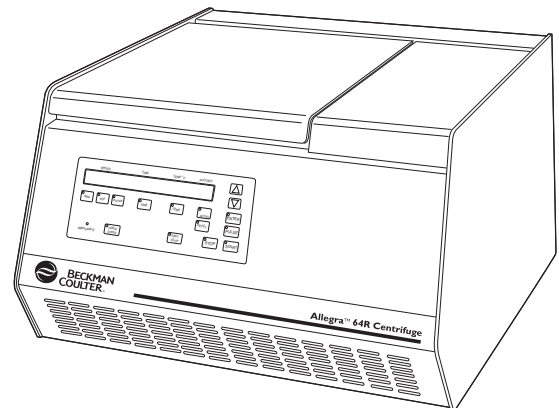

CE

B04846AA
September 2011



Beckman Coulter, Inc.
250 S. Kraemer Blvd.
Brea, CA 92821

 **BECKMAN
COULTER**

Allegra 64R
Compact Centrifuge
B04846AA (September 2011)

Copyright © 2011 Beckman Coulter, Inc.

All rights reserved. No part of this document may be reproduced or transmitted in any form or by any means, electronic, mechanical, photocopying, recording, or otherwise, without prior written permission from Beckman Coulter, Inc.

Find us on the World Wide Web at:

www.beckmancoulter.com

EC REP

Beckman Coulter Ireland, Inc.
Mervue Business Park, Mervue Galway, Ireland 353 91 774068

Beckman Coulter do Brasil Com e Imp de Prod de Lab Ltda
Estr dos Romeiros, 220 - Galpao G3 - Km 38.5
06501-001 - Sao Paulo - SP - Brasil
CNPJ: 42.160.812/0001-44

製造販売元：ベックマン・コールター株式会社
東京都江東区有明三丁目 5 番 7 号
TOC 有明ウエストタワー

贝克曼库尔特有限公司，
美国加利福尼亚州，Brea 市，S. Kraemer 大街 250 号，
邮编：92821 电话：(001) 714-993-5321

Safety Notice

Read all product manuals and consult with Beckman Coulter-trained personnel before attempting to operate instrument. Do not attempt to perform any procedure before carefully reading all instructions. Always follow product labeling and manufacturer's recommendations. If in doubt as to how to proceed in any situation, contact your Beckman Coulter Representative.

Alerts for Danger, Warning, Caution, and Note



DANGER indicates an imminently hazardous situation which, if not avoided, will result in death or serious injury.



WARNING indicates a potentially hazardous situation which, if not avoided, could result in death or serious injury.



CAUTION indicates a potentially hazardous situation, which, if not avoided, may result in minor or moderate injury. It may also be used to alert against unsafe practices.

NOTE NOTE is used to call attention to notable information that should be followed during installation, use, or servicing of this equipment.

Safety During Installation and/or Maintenance

This centrifuge weighs 102.1 kg/225 lb. DO NOT attempt to lift or move it without assistance from another person.

Be sure to use the anchoring system to secure the centrifuge in place. The anchoring system is designed to reduce the possibility of injury or damage which could result from instrument movement in the event of a major rotor mishap.

Any servicing of this equipment that requires removal of any covers can expose parts which involve the risk of electric shock or personal injury. Make sure that the power switch is turned off and the instrument is disconnected from the main power source, and refer such servicing to qualified personnel.

Do not replace any centrifuge components with parts not specified for use on this instrument.

Electrical Safety

To reduce the risk of electrical shock, this equipment uses a three-wire electrical cord and plug to connect this equipment to earth-ground. To preserve this safety feature:

- Make sure that the matching wall outlet receptacle is properly wired and earth-grounded. Check that the line voltage agrees with the voltage listed on the name-rating plate affixed to the instrument.
- Never use a three-to-two wire plug adapter.
- Never use a two-wire extension cord or a two-wire non-grounding type of multiple-outlet receptacle strip.

Do not place containers holding liquid on or near the chamber door. If they spill, liquid may get into the instrument and damage electrical or mechanical components.

Safety Against Risk of Fire

Certain electrical circuits within this equipment are protected by fuses against overcurrent conditions. For continued protection against the risk of fire, replace only with the same type and rating specified.

This centrifuge is not designed for use with materials capable of developing flammable or explosive vapors. Do not centrifuge such materials (e.g., chloroform, ethyl alcohol, etc.) in this instrument nor handle or store them within the 30-cm (1-ft) clearance “safety envelope” surrounding the centrifuge.

Mechanical Safety

For safe operation of the equipment, observe the following:

- Use only the Beckman rotors and accessories designed for use in this centrifuge.
- Before starting the centrifuge, make sure that the rotor tie-down screw is securely fastened.
- Do not exceed the maximum rated speed of the rotor in use.
- NEVER attempt to slow or stop the rotor by hand.
- Do not lift or move the centrifuge while the rotor is turning.
- If a glass tube breaks inside the chamber bowl, be careful when examining or cleaning the gasket or chamber, as sharp glass fragments may be embedded in their surfaces.
- NEVER attempt to override the door interlock system while the rotor is spinning.
- Maintain a 7.6-cm (3-in.) clearance envelope around the centrifuge (secured with antirotation kit) while it is running. During operation you should come within the envelope only to adjust instrument controls, if necessary. Never bring any flammable substances within the 30-cm (1-ft) area surrounding the centrifuge. Never lean on the centrifuge or place items on the centrifuge while it is operating.

Chemical and Biological Safety

Normal operation may involve the use of solutions and test samples that are pathogenic, toxic, or radioactive. Such materials should not be used in this instrument, however, unless all necessary safety precautions are taken.

- Observe all cautionary information printed on the original solution containers prior to their use.
- Handle body fluids with care because they can transmit disease. No known test offers complete assurance that they are free of micro-organisms. Some of the most virulent—Hepatitis (B and C) and HIV (I–V) viruses, atypical mycobacteria, and certain systemic fungi—further emphasize the need for aerosol protection. Handle other infectious samples according to good laboratory procedures and methods to prevent spread of disease. Because spills may generate aerosols, observe proper safety precautions for aerosol containment. Do not run toxic, pathogenic, or radioactive materials in this centrifuge without taking appropriate safety precautions. Biosafe containment should be used when Risk Group II materials (as identified in the World Health Organization *Laboratory Biosafety Manual*) are handled; materials of a higher group require more than one level of protection.
- Dispose of all waste solutions according to appropriate environmental health and safety guidelines.

It is your responsibility to decontaminate the instrument and accessories before requesting service by our Field Service representative.

Safety Notice, iii

Alerts for Danger, Warning, Caution, and Note, iii

Safety During Installation and/or Maintenance, iii

Electrical Safety, iv

Safety Against Risk of Fire, iv

Mechanical Safety, iv

Chemical and Biological Safety, v

Introduction, xiii

For In Vitro Diagnostic Use, xiii

Certification, xiii

Scope of this Manual, xiii

Conventions, xiv

CFC-Free Centrifugation, xiv

Recycling Label, xv

Specifications, xvi

Available Rotors, xviii

CHAPTER 1: Description, 1-1

Introduction, 1-1

Instrument Function and Safety Features, 1-1

Instrument Function, 1-1

Safety Features, 1-2

Name Rating Plate, 1-2

Chassis, 1-3

Housing, 1-3

Door, 1-3

Rotor Chamber, 1-3

Drive, 1-4

Temperature Sensing and Control, 1-4

Controls and Indicators, 1-4
Power Switch, 1-4
Control Panel, 1-5

CHAPTER 2: Installation Requirements, 2-1

Introduction, 2-1
Preinstallation Requirements, 2-1
Space Requirements, 2-2
Electrical Requirements, 2-3
Test Run, 2-4

CHAPTER 3: Operation, 3-1

Introduction, 3-1
Run Procedure, 3-1
Preparation and Loading, 3-2
Entering Run Parameters, 3-4
Starting a Run, 3-8
Changing Parameters During a Run, 3-9
Stopping a Run, 3-9
Unloading, 3-10
Summary of Run Procedures, 3-10

CHAPTER 4: Troubleshooting, 4-1

Introduction, 4-1
User Messages, 4-1
Other Possible Problems, 4-3
Emergency Access, 4-4

CHAPTER 5: Care and Maintenance, 5-1

Introduction, 5-1
Maintenance, 5-1
Preventive Maintenance, 5-1
Cleaning, 5-2
Tube Breakage, 5-3
Decontamination, 5-3
Sterilization and Disinfection, 5-3
Storage and Transport, 5-4
Storage, 5-4
Returning a Centrifuge, 5-4

Supply List, 5-4

Replacement Parts, 5-4

Supplies, 5-5

APPENDIX A: Program Library, A-1

Procedure, A-1

Beckman Coulter, Inc.

Allegra 64R, GS-15 Series, Allegra 21 Series, and
Spinchron 15 Series Centrifuge Warranty

Illustrations

- 1.1 The Allegra 64R Centrifuge, 1-2
- 1.2 Interior View of the Rotor Chamber, 1-3
- 1.3 The Power Switch, 1-4
- 1.4 The Control Panel, 1-5
- 2.1 Centrifuge Dimensions, 2-2
- 2.2 North American Electrical Socket, 2-3
- 3.1 Installing a Rotor, 3-3
- 3.2 Default Parameters, 3-4
- 4.1 Emergency Door Release, 4-4

Tables

3.1	Acceleration and Deceleration Rates (in seconds per 1000 rpm), 3-7
4.1	Error Message Chart, 4-2
4.2	Troubleshooting Chart, 4-3

For In Vitro Diagnostic Use

This Allegra 64R centrifuge is intended for the separation of components through the use of relative centrifugal force.

It is designed to separate human samples, including blood and other body fluids, for processing, analysis, and in vitro diagnostic testing, as well as nonhuman body samples and chemicals, including industrial and environmental samples.

This centrifuge should be operated by qualified personnel only.

Certification

To ensure full system quality, Beckman Coulter Allegra® 64R centrifuges have been manufactured in a registered ISO 9001 or 13485 facility. They have been designed and tested to be compliant (when used with Beckman Coulter rotors) with the laboratory equipment requirements of applicable regulatory agencies. Declarations of conformity and certificates of compliance are available at www.beckmancoulter.com.

Scope of this Manual

This manual is designed to familiarize you with the Allegra 64R centrifuge, its functions, specifications, operation, and routine operator care and maintenance.

We recommend that you read this entire manual, especially the *Safety Notice* and all safety-related information, before operating the centrifuge or performing instrument maintenance.

- The following introductory pages contain the instrument specifications, as well as space, electrical, and temperature conditions required for optimal centrifuge performance. A list of available rotors is also included.
- [CHAPTER 1](#) provides a brief physical and functional description of the centrifuge and the operating controls and indicators.
- [CHAPTER 2](#) contains instructions for installing and connecting the centrifuge.
- Procedures for operating the centrifuge are summarized in [CHAPTER 3](#).

- [CHAPTER 4](#) lists possible error messages and/or malfunctions, together with probable causes and corrective actions required.
- Procedures for operator care and maintenance are presented in [CHAPTER 5](#), as well as a brief list of supplies and replacement parts.
- A Program Library chart is provided at the back of this manual. You can use this chart to record the parameters of a run for later duplication of the run conditions.

NOTE If the centrifuge is used in a manner other than specified in this manual, the safety and performance of this equipment could be impaired. Further, the use of any equipment other than that intended for use by Beckman Coulter has not been evaluated for safety. Use of any equipment not specifically recommended in this manual is the sole responsibility of the user.

Conventions

Certain symbols are used in this manual to call out safety-related and other important information. These international symbols may also be displayed on the centrifuge and are reproduced on the inside of the back cover.

Typographic Conventions

Certain typographic conventions are used throughout this manual to distinguish names of user interface components, such as keys and displays.

- *Key names* (for example, **START** or **ENTER**) and *display names* (for example, **TEMP°C** or **SPEED**) appear in bold type.
- *Cursor keys*, used to increment values up or down when setting parameters, are shown as up and down arrows (▲ or ▼).

CFC-Free Centrifugation

To ensure minimal environmental impact, no CFCs are used in the manufacture or operation of Allegra 64R centrifuge.

Recycling Label



This symbol is required in accordance with the Waste Electrical and Electronic Equipment (WEEE) Directive of the European Union. The presence of this marking on the product indicates.

1. the device was put on the European market after August 13, 2005 and
2. the device is not to be disposed via the municipal waste collection system of any member state of the European Union.

It is very important that customers understand and follow all laws regarding the proper decontamination and safe disposal of electrical equipment. For Beckman Coulter products bearing this label please contact your dealer or local Beckman Coulter office for details on the take back program that will facilitate the proper collection, treatment, recovery, recycling and safe disposal of the device.



Specifications

Only values with tolerances or limits are guaranteed data. Values without tolerances are informative data, without guarantee.









Specification	Description
Set speed	0 to 30,000 RPM (in 100-RPM increments) <i>or</i> equivalent RCF
Speed display	digital display indicates actual rotor speed ± 50 RPM (actual RCF can be selected during operation)
Set time	to 9 hr 59 min <i>or</i> continuous
Time display	time remaining in run (timed run) <i>or</i> ∞ and elapsed time (continuous run)
Acceleration	ten acceleration profiles
Deceleration	ten deceleration profiles
Temperature	<ul style="list-style-type: none"> • Temperature setting <ul style="list-style-type: none"> — -20 to $+40^{\circ}\text{C}$ (in 1°C increments) • Operating range <ul style="list-style-type: none"> — 2 to $40^{\circ}\text{C}^{\text{a}}$ • Ambient temperature range <ul style="list-style-type: none"> — 10 to 35°C • Ambient temperature range for optimum operation <ul style="list-style-type: none"> — 10 to 25°C
Humidity restrictions	$<95\%$ (noncondensing)

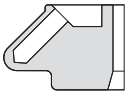
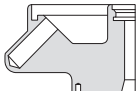
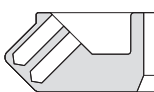

Specification	Description
Dimensions	<ul style="list-style-type: none"> • Width <ul style="list-style-type: none"> — 61 cm (24 in.) • Depth <ul style="list-style-type: none"> — 66 cm (26 in.) • Height, door closed <ul style="list-style-type: none"> — 38 cm (15 in.) • Height, door open <ul style="list-style-type: none"> — 84 cm (33 in.)
Weight	102.1 kg (225 lb)
Clearances (sides and rear)	7.6 cm (3.0 in.)
Electrical requirements	<ul style="list-style-type: none"> • 50 Hz, 200 VAC, 12 A • 60 Hz, 200 VAC, 12 A • 60 Hz, 208 VAC, 12 A • 50 Hz, 230 VAC, 12 A
Electrical supply	Class I
Motor	760 W
Maximum heat dissipation into room under steady-state conditions	5400 Btu/h (1.58 kW)
Noise level 0.91 m (3 ft) in front of instrument	65 dBa
Installation (overvoltage) category	II
Pollution degree	2 ^b

a. Temperature range depends on rotor in use and speed (see applicable rotor manual).

b. Normally only nonconductive pollution occurs; occasionally, however, a temporary conductivity caused by condensation must be expected.

Available Rotors

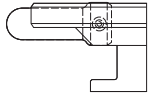
Rotor Profile	Description	Max RPM	Max RCF ^a (× g)	Max RPM at 4°C ^b	Max RCF* (× g) at 4°C ^b	Max Capacity (mL)	Rotor Part Number/ Rotor Manual Number
	F1202 Fixed Angle 45° Angle	30,000	64,400	28,500	58,120	12 × 2.0/1.5	364630 GS30-TB-006
	F2402H Fixed Angle 45° Angle	26,000 ^c	61,970	21,000	40,430	24 × 2.0/1.5	361171 GS-TB-021
	F3602 Fixed Angle 45° Angle	22,000	47,620/ 41,670	19,500	37,410/ 32,700	36 × 2.0/1.5	364600 GS-TB-006
	F0630 Fixed Angle 30° Angle	26,200 ^c	59,860	21,500	40,310	6 × 38.5	361231 GS-TB-014
	F0650 Fixed Angle 25° Angle	21,000	41,420	18,500	32,140	6 × 50	364610 GS30-TB-004
	F0850 Fixed Angle 25° Angle	16,500	29,220	16,500	29,220	8 × 50	364640 GS-TB-003
	F0485 Fixed Angle 30° Angle	20,000	40,700	17,500	31,160	4 × 85	364620 GS30-TB-007
	F0685 Fixed Angle 25° Angle	15,500	26,320	15,000	24,650	6 × 85	364650 GS-TB-008
	F1010 Fixed Angle 35° Angle	26,000 ^c	57,440	22,500	43,020	10 × 10	361221 GS-TB-007
	C0650 (Conical) Fixed Angle 25° Angle	10,000	10,400	10,000	10,400	6 × 50	364670 GS-TB-009
	C1015 (Conical) Fixed Angle 25° Angle	10,000	10,400	10,000	10,400	10 × 15	364680 GS-TB-011

Rotor Profile	Description	Max RPM	Max RCF ^a ($\times g$)	Max RPM at 4°C ^b	Max RCF* ($\times g$) at 4°C ^b	Max Capacity (mL)	Rotor Part Number/ Rotor Manual Number
	S0410 Swinging Bucket Four buckets	10,000	10,730	10,000	10 730	4 \times 10	364660 GS30-TB-005
	H6002 BioSafe Bowl Rotor	12,200	12,400	12,200	12 400	60 \times 1.5/1.8 72 \times 600 μ L 84 \times 250 μ L	363000 GS30-TB-002

- a. Values have been rounded off.
- b. Measured at ambient temperature of 21°C.
- c. Reduce maximum speed to maintain temperature control for runs exceeding 10 minutes.

Description

Introduction

This section provides a brief physical and functional description of the Allegra 64R centrifuge. The operating controls and indicators are also described; instructions for their use are in [CHAPTER 3](#). Chemical compatibilities of materials listed in this manual can be found in Chemical Resistances (publication IN-175). Refer to the applicable rotor manuals for rotor descriptions.

Instrument Function and Safety Features

Instrument Function

The Allegra 64R is a refrigerated compact centrifuge that generates centrifugal forces required for a wide variety of applications. Together with any of several Beckman Coulter rotors designed specifically for use in these centrifuges, the applications include:

- Routine processing such as sample preparations, pelleting, extractions, purifications, concentrations, phase separations, receptor binding, and column centrifugations.
- Rapid sedimentation of protein precipitates, large particles, and cell debris.
- Preparation of subcellular organelles such as mitochondria, granules, and crude microsomes.
- Binding studies and separation of whole blood.
- Cell isolation.
- Crude protein preparations.
- Virus isolation.
- Nucleic acid plasmids and bacteriophages isolation.

The Allegra 64R centrifuge ([Figure 1.1](#)) is microprocessor-controlled, providing interactive operation. The instrument design features a brushless asynchronous motor, automatic rotor identification system, program memory that can repeat the previously used run parameters for a rotor, temperature control system, and a choice of acceleration and deceleration rates. User messages alert the operator to conditions that may need attention.

Chassis

Housing

The centrifuge housing is made of sheet steel, finished with urethane paint. The control panel is covered by a protective overlay made of coated polycarbonate.

Door

The solid-sheet aluminum door is secured to the housing by solid shafts. A dual electromechanical door lock system prevents operator contact with spinning rotors and prevents run initiation unless the door is shut and latched. The door is locked when a run is in progress and can be opened only when the rotor is stopped. (A light-emitting diode [LED] on the **OPEN DOOR** key lights up when the door can be opened.) In the event of a power failure, the door lock can be manually tripped for sample recovery (see [CHAPTER 4, Troubleshooting](#)).

Rotor Chamber

The rotor chamber is shown in [Figure 1.2](#). The drive shaft, mounting plate, rubber boot surrounding the drive shaft, thermistor, and rotor detector are visible in the chamber bottom. A gasket system around the chamber opening assures sealing. (Instrument gaskets have not been designed as bioseals for aerosol containment.)

Figure 1.2 Interior View of the Rotor Chamber

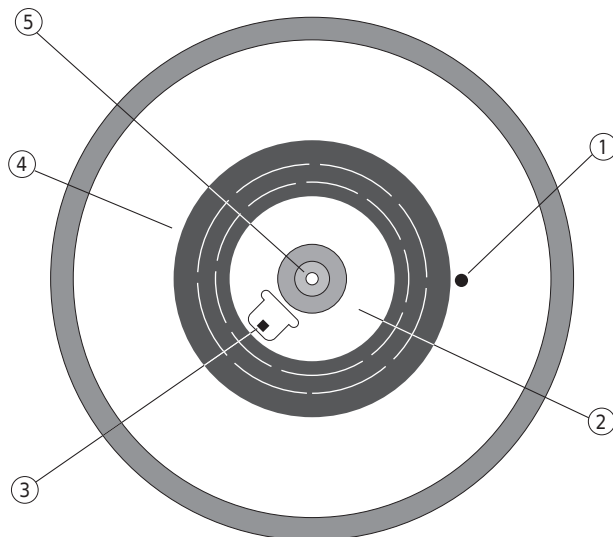

- | | |
|-------------------|----------------|
| 1. Thermistor | 4. Boot |
| 2. Mounting Plate | 5. Drive Shaft |
| 3. Rotor Detector | |

Drive

The asynchronous three-phase direct-drive motor is brushless for clean, quiet operation. A tie-down screw is used to attach the rotor to the drive shaft. The resilient suspension ensures that loads will not be disturbed by vibration, and prevents damage to the drive shaft if an imbalance occurs during centrifugation. Maximum braking may be selected to reduce deceleration time, allowing fast processing of samples; alternately, delicate gradients may be preserved using slower deceleration.

Temperature Sensing and Control

With the power on, the temperature control system is activated when the door is closed. The run temperature can be set between -20 and $+40^{\circ}\text{C}$. If no set temperature is entered, the centrifuge automatically selects the last entered temperature. (For the first run of a new centrifuge, the instrument selects 20°C as its operating temperature.) A thermistor in the rotor chamber continuously monitors chamber temperature. The microprocessor calculates the required chamber temperature to maintain the selected rotor temperature.

NOTE In the unlikely event of a complete cooling system failure, the drive will switch off if the chamber temperature reaches 65°C . Restarting the centrifuge will not be possible until the chamber is cooled.

Controls and Indicators

Power Switch

The power switch is located on the centrifuge side panel (see [Figure 1.3](#)). This two-position rocker switch (I, on; O, off) controls electrical power to the centrifuge.

NOTE The power must be turned on before the chamber door can be opened.

Figure 1.3 The Power Switch

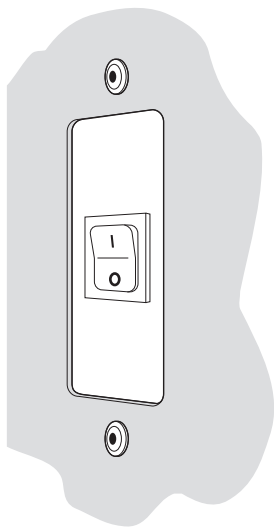

Control Panel

The control panel (Figure 1.4), mounted at an angle on the centrifuge front for easy visibility and access, comprises touch keys—system keys and parameter keys—and digital displays. The panel also contains an **IMBALANCE** light that flashes if rotor loads are severely out of balance.

Figure 1.4 The Control Panel

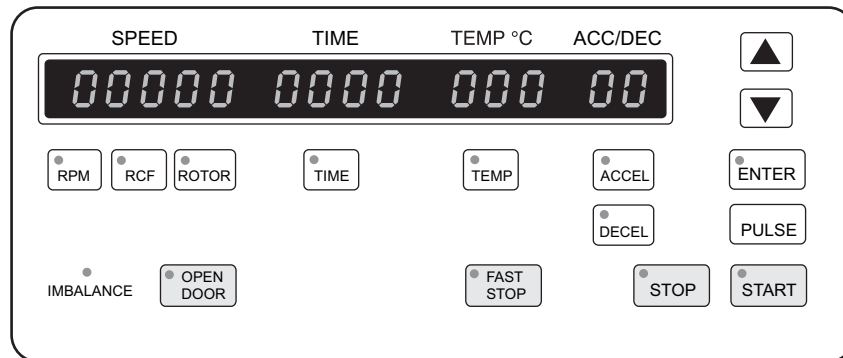

System Keys

The centrifuge operation is controlled through the system keys. Each key (except the **PULSE** key) has an LED in the upper left corner that lights to indicate that the key can be activated.

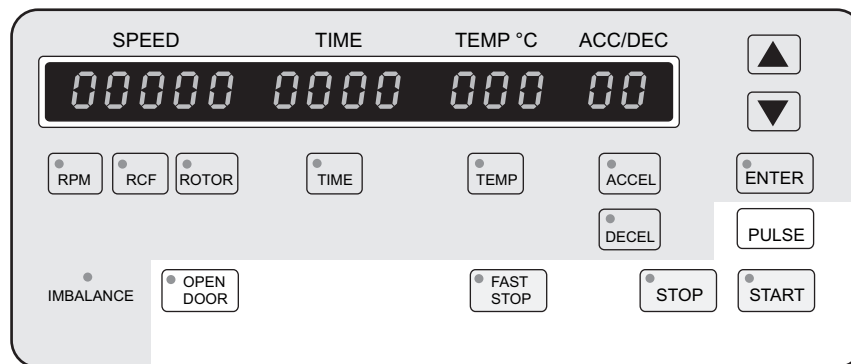

START	Pressing the START key causes the centrifuge run to begin. This key can also be used to abort a deceleration process and restart the centrifuge.
STOP	The STOP key can be pressed to end a run. The centrifuge decelerates to a complete stop according to the preselected deceleration curve. Deceleration can be terminated and the centrifuge restarted by pressing START again.
FAST STOP	Pressing the FAST STOP key causes the centrifuge to decelerate to a complete stop at the maximum rate. The deceleration cannot be interrupted; the centrifuge can only be restarted after the rotor stops and the door is opened and closed.

OPEN DOOR	Pressing the OPEN DOOR key unlatches the centrifuge door locks and allows the door to be opened. The centrifuge will accept this command <i>only when the rotor is completely stopped</i> and the OPEN DOOR key LED is lit.
PULSE	Pressing the PULSE key causes the installed rotor to accelerate up to the set speed for short-duration runs (as long as the key is pressed). Deceleration, at the maximum rate, begins when the key is released.

Parameter Keys

The parameter keys are used to set run conditions. Except for the cursor and **ENTER** keys, parameter keys are located beneath the applicable digital displays, which show the parameters as they are input. Each key (except for the cursor keys) has an LED in the upper left corner that lights to indicate operational readiness. The LEDs also blink if an incorrect parameter is entered.

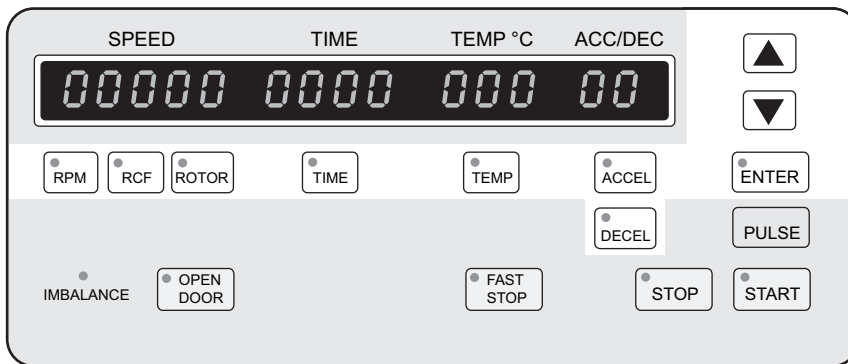

▲ ▼ (cursor keys)	The cursor keys are up and down arrow keys (▲ and ▼), which can be pressed to increment values up or down when setting parameters.
ENTER	Parameter (speed, time, temperature, and acceleration or deceleration curve) changes made while a run is in progress must be verified by pressing the ENTER key.
RPM	When the RPM key is pressed the last digit in the SPEED display (0) flashes, indicating that the speed can be entered in increments of 100 revolutions per minute (RPM). After the run starts, the actual RPM of the rotor is displayed.
RCF	The RCF key can be used to select the speed setting by desired relative centrifugal field (RCF). The corresponding RPM is automatically calculated and displayed during the run. If the RCF key is pressed during the run, the RCF value is shown in the SPEED display.
ROTOR	The centrifuge memory contains a list of the rotors that can be used, together with default parameters for each rotor. When the ROTOR key is pressed the number of the rotor used in the previous run is shown on the SPEED display. The rotor list can be scrolled through, using the cursor keys, until the required rotor number appears.

TIME	The TIME key is used to select the run duration. When the TIME key is pressed, the last digit on the TIME display flashes, indicating that the time can be entered with the cursor keys. <ul style="list-style-type: none">• <i>Timed run</i> — Run time up to 9 hours and 59 minutes can be set. If the minutes parameter exceeds 59, it is automatically converted into hours.• <i>Continuous run</i> — If a run time of less than 0 or more than 9 hours and 59 minutes is selected, continuous operation is activated. Time is not counted down, and the run will continue until the STOP or FAST STOP key is pressed.
TEMP	The TEMP key is used to select run temperature. When the TEMP key is pressed, the TEMP°C display flashes, indicating that the temperature can be entered with the cursor keys. Temperature can be set between -20 and +40°C.
ACCEL	The ACCEL key is used to select acceleration rates that will protect delicate gradients. When the ACCEL key is pressed, the ACC/DEC display flashes, indicating that one of ten preset rates can be entered with the cursor keys. Acceleration rates are described in Table 3.1 (in CHAPTER 3).
DECEL	The DECEL key is used to select deceleration rates that will maintain optimum separation while protecting delicate gradients. When the DECEL key is pressed, the ACC/DEC display flashes, indicating that one of ten preset rates can be entered with the cursor keys. Deceleration rate selections are described in Table 3.1 (in CHAPTER 3).

Digital Displays

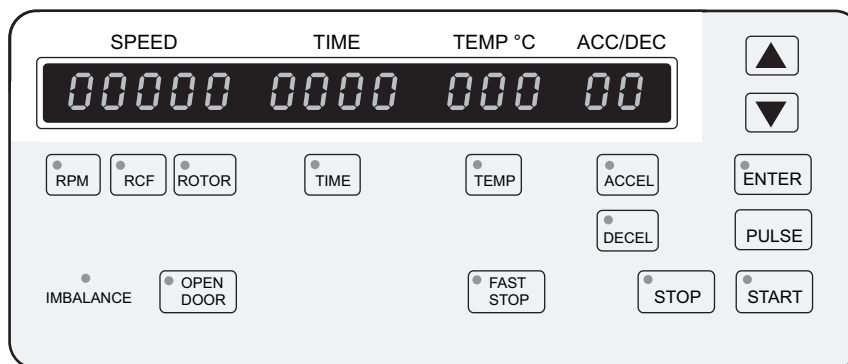

Digital displays indicate rotor speed, run time, rotor chamber temperature, and numbers that represent selected acceleration and deceleration profiles. When the power is turned on, they show the operating parameters of the most recent run performed before the power was turned off. The displays serve a dual purpose.

- When the run parameters are being set (the input mode), the displays show the set values (those selected by the operator). When a run- parameter key (for example, **TIME** or **RPM**) is pressed, the appropriate display flashes to indicate that data can be entered.
- The *actual* (real-time) operating conditions of the centrifuge are displayed during the run, after **START** is pressed.

NOTE Error messages (see [CHAPTER 4](#)) also appear on the displays, when applicable.

SPEED	<ul style="list-style-type: none"> • <i>In input mode</i> the SPEED display shows the value of the parameter being set, depending on the programming key pressed (RPM, RCF, or ROTOR). For example, if the ROTOR programming key is pressed, a rotor number appears on the SPEED display. • <i>During centrifugation</i>, the SPEED display shows the speed of the rotor in RPM. If the RCF key is pressed while the centrifuge is running, the RCF value is displayed.
TIME	<ul style="list-style-type: none"> • During a <i>timed run</i> (between 1 minute and 9 hours, 59 minutes), the TIME display begins counting down when the rotor starts to spin and continues the countdown until deceleration begins. The TIME display indicates the remaining run time in hours and minutes. • During a <i>continuous run</i> (less than 0 or more than 9 hours, 59 minutes selected), countdown time is not displayed. Instead, the infinity (∞) symbol, indicating continuous operation, lights up and the TIME display shows time elapsed since the run start. After 9 hours and 59 minutes the timer will reset to 0 and continue counting elapsed time.
TEMP°C	<p>During standby (that is, the centrifuge is turned on but not spinning) and operation, the TEMP°C display shows the actual temperature inside the rotor chamber ($\pm 2^\circ\text{C}$ at an ambient temperature of 20°C).</p>
ACC/DEC	<p>The ACC/DEC display shows the acceleration rate that was selected for the run. The deceleration curve number can be displayed by pressing the DECCEL key.</p>

Installation Requirements

Introduction

Do not attempt to install this centrifuge. Its purchase price includes installation by Beckman Coulter personnel. Installation by anyone other than an authorized Beckman Coulter representative invalidates any warranty covering the instrument.

 **WARNING**

This centrifuge weighs 102.1 kg/225 lb. DO NOT attempt to lift or move it without assistance from another person.

Preinstallation Requirements

Preinstallation requirements have been sent prior to shipment of the instrument. The following information is provided in case the centrifuge must be relocated.

 **WARNING**

Do not place the centrifuge near areas containing flammable reagents or combustible fluids. Vapors from these materials could enter the centrifuge air system and be ignited by the motor.

 **WARNING**

Maintain a 7.6-cm (3-in.) clearance envelope around the centrifuge (secured with the antirotation kit) while it is running. No persons should be within this clearance boundary while the centrifuge is operating. Do not handle or store hazardous materials within the 30-cm (1-ft) area surrounding the centrifuge.

Space Requirements

- 1 Select a location away from heat-producing laboratory equipment, with sufficient ventilation to allow for heat dissipation.
- 2 Position the centrifuge on a level surface, such as a sturdy table or laboratory bench that can support the weight of the centrifuge (102.1 kg /225 lb) and resist vibration.
- 3 In addition to space for the centrifuge itself, allow 7.6-cm (3-in.) clearances at the sides and back of the centrifuge to ensure sufficient air circulation. (See Figure 2.1.)
Additional clearance is required on the left side to allow access to the power switch.
The centrifuge must have adequate air ventilation to ensure compliance to local requirements for vapors produced during operation.

Figure 2.1 Centrifuge Dimensions

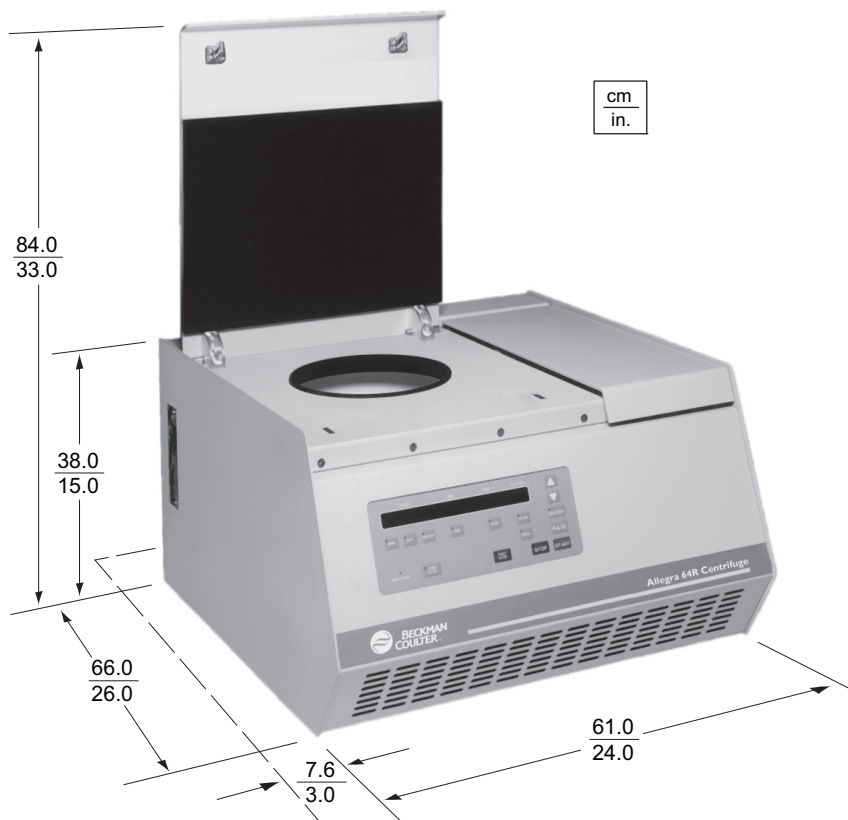

- 4 Use the anti-rotation kit to secure the centrifuge to the bench or table as described in publication GS30-TB-003.

The anti-rotation system is designed to reduce the possibility of injury or damage that could result from instrument movement in the event of a major rotor mishap.

NOTE During transport between areas with varying temperatures, condensation may occur inside the centrifuge. Allow sufficient drying time before running the centrifuge.

Electrical Requirements

200-V centrifuge	190–210 VAC, 12 A, 50 Hz
200-V centrifuge	190–210 VAC, 12 A, 60 Hz
208-V centrifuge	198–218 VAC, 12 A, 60 Hz
230-V centrifuge	220–240 VAC, 12 A, 50 Hz

To reduce the risk of electrical shock, this centrifuge uses a 1.8-m (6-ft) three-wire electrical cord (to be attached to the IEC 320/CEE-20 AC power connector at the rear of the instrument) and plug to connect the centrifuge to earth-ground. The plug for use in North America is the NEMA 6-15P; a NEMA 6-15R socket (see [Figure 2.2](#)) should be available. To preserve this safety feature:

- Make sure that the matching wall outlet receptacle is properly wired and earth-grounded. Check that the line voltage agrees with the voltage listed on the name rating plate affixed to the centrifuge.
- Never use a three-to-two wire plug adapter.

Figure 2.2 North American Electrical Socket

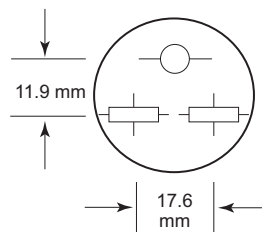

- Never use a two-wire extension cord or a two-wire non-grounding type of multiple-outlet receptacle strip.
- If there is any question about voltage, have a qualified service person measure it under load while the drive is operating.

To ensure safety the centrifuge should be wired to a remote emergency switch (preferably outside the room where the centrifuge is housed, or adjacent to the exit from that room), in order to disconnect the instrument from the main power source in case of a malfunction.

Test Run

NOTE The centrifuge must be plugged in and the power switch turned to on position (I) before the door can be opened.

We recommend that you make a test run to ensure that the centrifuge is in proper operating condition following shipment. See [CHAPTER 3](#) for instructions on operating the centrifuge.

After completing the test run, return the pre-addressed warranty card included with this literature. This will validate the centrifuge warranty and ensure your receipt of further information regarding new accessories and/or modifications as they become available.

Introduction

This section contains operating procedures for the centrifuge, using any of the Beckman Coulter rotors designed for use in this centrifuge. Refer to the applicable rotor manual for instructions on preparing the rotor for centrifugation. To prevent condensation, keep the centrifuge door closed and the power turned off (O) when the centrifuge is not in use.

 **WARNING**

Normal operation may involve the use of solutions and test samples that are pathogenic, toxic, or radioactive. Operator error or tube failure may generate aerosols. Do not run potentially hazardous materials in this centrifuge unless all appropriate safety precautions are taken. Always use the appropriate rotors and adapters.

 **WARNING**

The centrifuge must not be used in the vicinity of flammable liquids or vapors, and such materials should not be run in the centrifuge. During operation you should come within the 7.6 cm (3-in.) clearance envelope only to adjust instrument controls, if necessary. Never bring any flammable substances within the 30-cm (1 ft) area surrounding the centrifuge. Do not lean on the centrifuge or place items on the centrifuge while it is operating.

Run Procedure

The following detailed operating procedures are summarized at the end of this section. If you are an experienced user of this centrifuge, you can turn to the summary for a quick review of operating steps.

Preparation and Loading

For fast temperature equilibration, cool or warm the rotor to the required temperature before the run.

NOTE For high-speed runs at temperatures of 20°C or higher, prime the refrigeration system by running the instrument at 10°C for 5 to 10 minutes beforehand to prevent overheating.

- 1 Check the name rating plate for the correct voltage, then plug the power cord into the wall receptacle.
- 2 Press the power switch to on (I).
- 3 Press the **OPEN DOOR** key and lift the door up; it will remain in the open position.
- 4 Use the T-handle wrench to turn the rotor tie-down screw to the left (counterclockwise).
 - a. Remove the tie-down screw.

 **CAUTION**

Do not drop the rotor onto the drive shaft. The shaft can be damaged if the rotor is forced sideways or dropped onto it. Install the rotor by centering it over the shaft and carefully lowering it straight down.

- 5 Install the rotor (see [Figure 3.1](#)) according to the instructions in the rotor manual.
 - a. Always run the rotor with a balanced load.
 - b. (If you are using a swinging bucket rotor, fill all four positions on the yoke with buckets.)
- 6 Attach the tie-down screw to the drive shaft by turning it to the right (clockwise).
- 7 Use the T-handle wrench to tighten the tie-down screw on the shaft.

 **CAUTION**

If the rotor is left in the centrifuge between runs, make sure the rotor is seated on the drive shaft and the tie-down screw is tight before each run. (It is best to remove the rotor from the centrifuge if a long period between runs is anticipated.)

- 8 If using a fixed-angle rotor with a lid, attach the lid.
 - a. Tighten the lid with the T-handle wrench.

Figure 3.1 Installing a Rotor

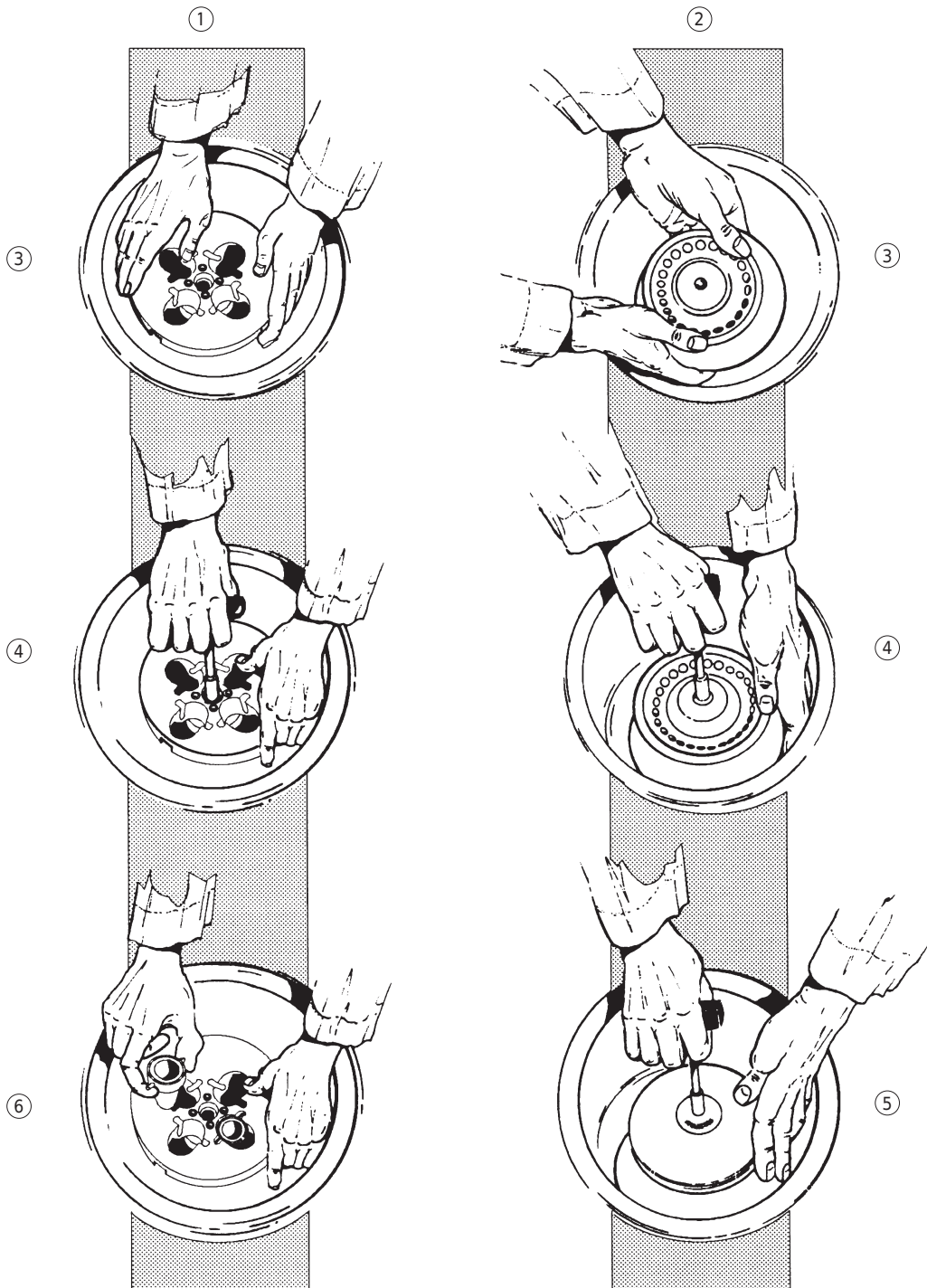

1. Swinging Bucket Rotor
2. Fixed Angle Rotor
3. Lower the rotor straight down onto the drive shaft

4. tighten the tie-down screw to the right (clockwise) onto the drive shaft
5. attach the lid and tighten with the T-handle wrench
6. Seat filled buckets on the yoke pins

- 9 Close the centrifuge door and push firmly down on both sides of the door front until you hear both latches engage.

Entering Run Parameters

When the power is applied for the initial use (no previous runs), default values will be displayed (see Figure 3.2). The centrifuge has an internal memory that stores previously used run parameters (or programs) for each rotor that has been centrifuged. After the initial use, the program (parameters) of the latest previous run will be displayed when power is applied.

Figure 3.2 Default Parameters

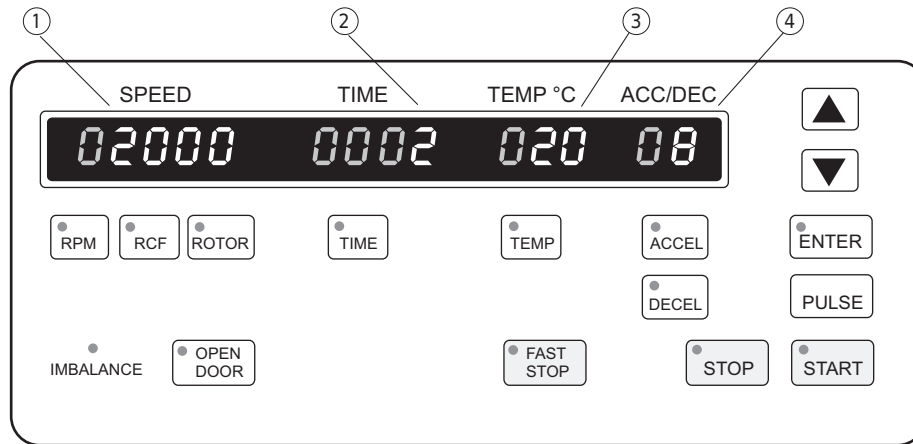

1. The centrifuge will accelerate to 2000 RPM
2. The run duration will be 2 minutes
3. The chamber will be cooled to 20°C
4. The acceleration curve is 8

NOTE A Program Library is provided at the back of this manual. You can use this chart to record the parameters of a run for later duplication of the run conditions.

When run parameters for a rotor have been entered, as described below, they will be retained in the centrifuge memory and can be recalled by simply entering the rotor number. The recalled program can then be used for the current run or can be altered as required.

Selecting a Rotor Number

The rotor number is engraved on each rotor (and on the lid of fixed angle rotors). The centrifuge internal memory contains a list of all rotors that can be run in the centrifuge, together with acceptable run parameters for each rotor. If you enter an unauthorized rotor number then press the **START** key, an error message will be displayed and the run will be aborted shortly after the rotor starts spinning.

-
- 1 Press the **ROTOR** key.
 - The number of the last rotor previously centrifuged appears on the **SPEED** display.
 - 2 Press the ▲ or ▼ cursor key until the number of the rotor in use is displayed.
 - 3 Press **ENTER**.
 - Nominal parameter values (time, temperature, speed, acceleration and deceleration curves) for the selected rotor will be displayed.
 - You can use these parameters or set new values for the run.
-

Setting Run Speed

Centrifuge speed can be set for up to the maximum rated speed of the selected rotor. Either revolutions per minute (RPM) or relative centrifugal field (RCF) can be used to select speed. During centrifugation, the **SPEED** display indicates the actual run speed of the rotor.

NOTE Use only the RPM mode to set run speeds for the H6002 bowl rotor. In the bowl rotor, RCF varies according to the tube in use, as indicated in the rotor manual (publication GS30-TB-002). If you use the RCF mode to set run speed, the centrifuge will select an RPM level based on the r_{\max} of the largest tube, resulting in a speed too low to achieve the required RCF in the shorter tubes. Also note that the control panel will display the RCF calculated for the r_{\max} of the 1.8- or 1.5-mL tube, which will not accurately represent the RCF for shorter tubes. Refer to the rotor manual for the RCF values of shorter tubes.

Setting RPM

-
- 1 Press the **RPM** key.
 - The last digit on the **SPEED** display (0) flashes, indicating that the RPM can be entered (in 100-RPM increments) with the cursor keys.
 - 2 Press the ▲ or ▼ cursor key until the required RPM is displayed.
 - The corresponding RCF will be automatically calculated by the centrifuge, but the RPM value will be displayed during the run.
 - (You can check the RCF during the run by pressing the **RCF** key while the centrifuge is running.)
-

Setting RCF

- 1 Press the **RCF** key.
 - The last digit on the **SPEED** display (**0**) flashes, indicating that the RCF can be entered.
 - 2 Press the ▲ or ▼ cursor key until the required RCF is displayed.
 - The corresponding RPM will be automatically calculated and the centrifuge will run at the calculated speed.
 - The RPM value will be displayed during the run.
 - (You can check the RCF during the run by pressing the **RCF** key while the centrifuge is running.)
-

Setting Run Time

Run time can be set for either a timed run or continuous operation.

- *Timed run* — Time can be set for up to 9 hours and 59 minutes (if the minutes parameter entered exceeds 59, it is automatically converted into hours). During centrifugation, the **TIME** display begins counting down when the rotor starts to spin and continues the count-down until deceleration begins. The **TIME** display shows the time remaining in the run, in hours and minutes. When the time display reaches zero, the run ends.
 - *Continuous run* — If a run time of less than 0 or more than 9 hours and 59 minutes is selected, continuous operation is activated. Time is not counted down during continuous operation; instead, the infinity (∞) symbol, indicating continuous operation, lights up and time elapsed since the run start is displayed. The run will continue until the **STOP** or **FAST STOP** key is pressed.
-

- 1 Press the **TIME** key.
 - The last digit on the **TIME** display flashes, indicating that the time can be entered with the cursor keys.
 - 2 Press the ▲ or ▼ cursor key until required run duration is displayed.
-

Setting Run Temperature

Run temperature can be set between -20 and +40°C.

NOTE Temperatures may vary slightly between instruments. If sample temperature is crucial, test temperature settings on your instrument using water samples.

- 1 Press the **TEMP** key.
 - The **TEMP°C** display flashes, indicating that the temperature can be entered with the cursor keys.

- 2 Press the ▲ or ▼ cursor key until the required run temperature is displayed.

NOTE For runs at other than room temperature, refrigerate or warm the rotor beforehand for fast equilibration. For low-temperature runs, precool the centrifuge by running a 30-minute cycle at the required temperature (with a precooled rotor installed) with the speed set at about 2000 RPM.

For runs at room temperature and above at maximum rated speed, use acceleration rate 1 (50-Hz centrifuge) to avoid temperature spike during acceleration.

Setting Acceleration Rate

The **ACCEL** key is used to select acceleration rates that will protect delicate gradients. When the **ACCEL** key is pressed, the **ACC/DEC** display flashes, indicating that one of the 10 preset acceleration rates can be entered with the cursor keys. The selected rate will depend on the type of run you are performing. For pelleting runs, where sample mixing is not a concern, maximum acceleration can be used. However, if delicate gradients are being run, a lower setting may be needed. Acceleration rates are listed in [Table 3.1](#).

Table 3.1 Acceleration and Deceleration Rates (in seconds per 1000 RPM)^a

Curve	Acceleration Rate (seconds per 1000 RPM)	Deceleration Rate (seconds per 1000 RPM)
9	1.0	1.0
8	2.0	2.0
7	2.5	2.5
6	3.0	3.0
5	3.5	3.5
4	4.0	4.0
3	4.5	4.5
2	5.0	5.0
1	5.5	5.5
0	6.0	no brake

a. Times are approximate; actual times will vary depending on the size and weight of the rotor in use, rotor load, run speed, and voltage fluctuation.

-
- 1 Press the **ACCEL** key.
 - The **ACC/DEC** display flashes, indicating that the selected rate number can be entered with the cursor keys.
-

- 2 Press the ▲ or ▼ cursor key until the required number is displayed.
-

Setting Deceleration Rate

The **DECEL** key is used to select deceleration rates that will maintain optimum separation. When the **DECEL** key is pressed, the **ACC/DEC** display flashes, indicating that one of the ten preset deceleration rates can be entered with the cursor keys. The selected rate will depend on the type of run you are performing. For pelleting runs, where sample mixing is not a concern, maximum brake can be used. However, if delicate gradients are being run, a lower brake setting may be needed. Deceleration rates are listed in [Table 3.1](#).

-
- 1 Press the **DECEL** key.
 - The **ACC/DEC** display flashes, indicating that the selected number can be entered with the cursor keys.
-

- 2 Press the ▲ or ▼ cursor key until the required number is displayed.
-

Starting a Run

The run can be started using the parameters in memory from a previous run, or using new or changed parameters that you enter using the procedure described above.

-
- 1 Check that all parameters are correct and the door is shut and latched.
-
- 2 Press the **ENTER** key, then the **START** key.
 - As the run begins, the instrument rotor identification system compares the rotor in the chamber to the entered rotor number and the speed entered.
 - An incorrect rotor identification, or set speed greater than the *rotor's maximum permitted speed*, will result in an error code and the centrifuge will shut down.
 - (See [CHAPTER 4, Troubleshooting](#), for information on error codes.)

- a. The error must be cleared and an appropriate speed entered before the centrifuge can be started.
 - Throughout the run, checks are made to ensure that the rotor does not exceed set speed.
 - The **SPEED** display indicates the rotor speed in RPM.
 - (The RCF can be checked by pressing the **RCF** key.)
 - A blinking LED at the bottom of the **TIME** display indicates that the run is in progress.
 - This display also shows the time remaining in the run (or ∞ and elapsed time for continuous operation).

 **WARNING**

Do not attempt to override the door interlock system while the rotor is spinning.

 **CAUTION**

Do not lift or move the centrifuge while the rotor is spinning.

NOTE Power line interruptions automatically initiate an intended rotor drive deceleration and run time reset. Power interruptions are momentary power dropout events of partial or complete power cycles. The centrifuge panel display may momentarily blank and recover. The **TIME** display resets to the entered run time value and the rotor decelerates under the entered run deceleration profile. Actual rotor speed is displayed during deceleration. Allow the rotor to come to a complete stop. To restart the centrifuge, press **ENTER**, then **START**.

Changing Parameters During a Run

While a run is in progress, run parameters (speed, time, temperature, and acceleration or deceleration rate) can be altered without stopping the run. Run duration can also be changed from continuous to a specified time period, or from a specified time period to continuous.

NOTE The deceleration rate cannot be changed after deceleration starts.

Use the parameter keys as described under *Entering Run Parameters*. Parameter changes made during a run must be verified by pressing the **ENTER** key. For example, to change run speed during centrifugation:

- 1 Press the **RPM** key.
 - The last digit on the **SPEED** display flashes, indicating that the RPM can be raised or lowered with the cursor keys.
- 2 Press the **▲** or **▼** cursor key until the required RPM is displayed.

-
- 3 Press the **ENTER** key.
 - The current RPM value will be displayed, changing to the new value as the rotor accelerates or decelerates to the new speed selected.
 - The corresponding RCF will be automatically calculated by the centrifuge.
-

Stopping a Run

A timed run will end automatically when the **TIME** display counts down to zero. To end a run in progress for any reason:

-
- 1 Press the **STOP** key for normal deceleration as selected by the deceleration curve.

(or)

Press the **FAST STOP** key for deceleration at the maximum rate (see [Table 3.1](#)).

NOTE If you press **FAST STOP** the deceleration process cannot be interrupted; the rotor must come to a complete stop and the door opened and closed before the centrifuge can be restarted.

-
- 2 *After the rotor stops spinning* and the **OPEN DOOR** light comes on, press the **OPEN DOOR** key to release the door latches, then open the door.

NOTE To prevent chamber icing, use a sponge to wipe condensation out of the chamber bowl between runs.

Unloading

After completing a run, unload the rotor following the instructions in the applicable rotor manual.



If disassembly reveals evidence of leakage, you should assume that some fluid escaped the rotor. Apply appropriate decontamination procedures to the centrifuge and accessories.

Summary of Run Procedures

For runs at other than room temperature, refrigerate or warm the rotor beforehand for fast equilibration. For low-temperature runs, precool the centrifuge by running a 30-minute cycle (with a precooled rotor installed) at the required temperature with the speed set at 2000 RPM.

- 1 Press the POWER switch to on (I).
 - a. Open the centrifuge door (press the **OPEN DOOR** key and lift the door up).
 - 2 Install the rotor according to the instructions in the rotor manual.
 - a. *Always run the rotor with a balanced load.*
 - 3 Close the centrifuge door and push firmly down on it until you hear both latches engage.
 - 4 Enter run parameters:
 - a. Select a rotor number — **ROTOR**, ▲ or ▼, **ENTER**
 - b. Set run speed — **RPM**, ▲ or ▼; or **RCF**, ▲ or ▼
 - c. Set run duration — **TIME**, ▲ or ▼
 - d. Set run temperature — **TEMP**, ▲ or ▼
 - e. Select acceleration rate (0 through 9) — **ACCEL**, ▲ or ▼
 - f. Select deceleration rate (0 through 9) — **DECEL**, ▲ or ▼
 - 5 Check that all parameters are correct and the door is shut and latched, then press the **ENTER** key, then the **START** key.
-

 **WARNING**

Never attempt to override the door interlock system while the rotor is spinning.

 **CAUTION**

Do not lift or move the centrifuge while the rotor is spinning.

- 6 Wait for the set time to count down to zero, or end the run by pressing either the **STOP** key or the **FAST STOP** key.
- 7 After the rotor stops spinning and the **OPEN DOOR** light comes on, press the **OPEN DOOR** key to release the door latch; open the door.

-
- 8** Unload the rotor according to instructions in the appropriate rotor manual.



If disassembly reveals evidence of leakage, you should assume that some fluid escaped the rotor. Apply appropriate decontamination procedures to the centrifuge and accessories.

Troubleshooting

Introduction

This section lists possible malfunctions, together with probable causes and corrective actions required. Maintenance procedures are contained in [CHAPTER 5](#). For any problems not covered here contact Beckman Coulter Field Service.

NOTE It is your responsibility to decontaminate the centrifuge, as well as any rotors and accessories, before requesting service by Beckman Coulter Field Service.

User Messages

 **CAUTION**

If the message SER appears on the display, do not press any keys while the message is displayed. Turn the centrifuge power off (O) and back on (I) to clear the message. This message indicates that you have inadvertently accessed the service mode. Pressing any keys while in this mode could erase the centrifuge memory and critically interfere with future operation.

If a problem occurs during operation, the rotor will decelerate to a stop and an error code will appear on the **SPEED** display. Messages may result from incorrect input or from an equipment malfunction. Refer to [Table 4.1](#) to determine the nature of the problem and recommended actions. If you are unable to correct the problem, call Beckman Coulter Field Service. To help diagnose and correct the problem, provide as much information as you can:

- The error number that appears on the display.
- The operating situation when the error occurred (rotor in use, speed, load type, etc.).
- Any unusual environmental and/or operating conditions (ambient temperature, voltage fluctuations, etc.).
- Add any other information that may be helpful.

Table 4.1 Error Message Chart^a

Error Number	Problem	Result	Recommended Action
1 through 23, 25 and 26, 28 through 30 32, 36, 39 and 40, 44 through 60, 63 through 68	Microprocessor or mechanical malfunction	Deceleration to full stop; run cannot be restarted	After rotor comes to a complete stop, turn the power off (O), then back on (I) to reset.
23 and 24, 27, 31, 33 through 35, 37 and 38, 41 through 43, 62	Microprocessor or mechanical malfunction	Deceleration to full stop; run cannot be restarted	After rotor comes to a complete stop, open and close the centrifuge door, then restart.
69 through 77	Microprocessor malfunction	Run cannot start until error is cleared	Turn the power off (O), then back on (I) to reset.
78 through 80	Error during closing of door	Run cannot start	<ol style="list-style-type: none"> 1. Remove debris in latch. 2. Close lid quickly. 3. Turn the power off (O), then back on (I) to reset.
81	"Door open" detected during run	Maximum deceleration to full stop	After rotor comes to a complete stop, shut the centrifuge door, turn the power off (O), then back on (I) to reset.
82, 83	Door does not open	—	See <i>Emergency Access</i> , below.
84	Heat sink overtemperature	Deceleration to full stop	<ol style="list-style-type: none"> 1. Check that ambient temperature is within a the limits shown in <i>Specifications</i>. 2. Check air inlets and exhausts for obstructions.
85 through 87	Rotor chamber overtemperature	Deceleration to full stop	After the motor has cooled, restart. If the problem persists, call Beckman Coulter Field Service.
90 through 96	Temperature sensor malfunction	Maximum deceleration to full stop	Turn the power off (O), then back on (I) to reset.
98	Rotor not recognized	Maximum deceleration to full stop	Check that the installed rotor is usable in the centrifuge. If incorrect, install an authorized rotor; if rotor is authorized and problem persists, call Beckman Coulter Field Service.
99	Rotor recognized but incorrect	Maximum deceleration to full stop	Input correct parameters for the rotor in use, then restart.

a. If the recommended action does not correct the problem, call Beckman Coulter Field Service.

Other Possible Problems

Possible malfunctions that may not be indicated by diagnostic messages are described in [Table 4.2](#), along with probable causes and corrective actions required. Possible causes for each problem are listed in the probable order of occurrence. Perform the recommended corrective action in sequence, as listed. If you are unable to correct the problem, call Beckman Coulter Field Service.

Table 4.2 Troubleshooting Chart

Problem	Problem/Result	Recommended Action
Imbalance LED lights and rotor decelerates to stop	<ol style="list-style-type: none"> 1. Rotor is out of balance 2. Centrifuge is misaligned (tilted) 3. Centrifuge was moved during operation 4. Drive error (mechanical damage) 	<ol style="list-style-type: none"> 1. Check to be sure the rotor is in good condition and is loaded symmetrically around the center of rotation, with containers of equal weight and density (within 6 grams) opposite each other. 2. Align the centrifuge on the bench or table. 3. After the rotor comes to a complete stop, open and close the centrifuge door, then restart. 4. Call Beckman Coulter Field Service
Rotor cannot achieve set speed	<ol style="list-style-type: none"> 1. Line voltage below rating 2. Electrical failure 3. Motor failure 	<ol style="list-style-type: none"> 1. Have a qualified service person measure line voltage while the instrument is operating. 2. Make sure both ends of the power cord are securely connected; call Beckman Coulter Field Service. 3. Call Beckman Coulter Field Service
Door will not open	<ol style="list-style-type: none"> 1. Rotor spinning 2. Power not on 3. Source power failure 4. Latch stuck 	<ol style="list-style-type: none"> 1. Wait until the rotor stops. 2. Plug in the power cord; turn power on (I). 3. See Emergency Access, below. 4. See Emergency Access, below.
Displays are blank	<ol style="list-style-type: none"> 1. Power not on 2. Electrical failure 3. Fuse blown 	<ol style="list-style-type: none"> 1. Plug in the power cord; turn power on (I). 2. Make sure both ends of the power cord are securely connected; call Beckman Coulter Field Service. 3. Call Beckman Coulter Field Service.
TEMP °C display flashes	Chamber temperature is >25°C higher than selected temperature	Precool rotors before running at low temperatures. Precool rotor chamber by running a 30-minute cycle at the desired temperature with the speed set at about 2000 RPM. If a lower temperature deviation alert is required, contact Beckman Coulter Field Service.
Chamber does not reach selected temperature	Centrifuge cannot maintain selected temperature for rotor in use at speed selected	Refer to appropriate rotor bulletin for temperature and speed requirements. Also, precool rotors before running at low temperatures. Precool rotor chamber by running a 30-minute cycle at the desired temperature with the speed set at 2000 RPM.

Emergency Access

If the facility power fails only momentarily, the centrifuge will resume operation when power is restored and the rotor will return to set speed. However, if the rotor comes to a complete stop you will have to restart the run when the power is restored. In the event of an extended power failure, it may be necessary to trip the door-locking mechanism manually to remove the rotor and retrieve your sample (see [Figure 4.1](#)).

⚠ WARNING

Any maintenance procedure requiring removal of a panel exposes the operator to the possibility of electrical shock and/or mechanical injury. Therefore, turn the power off and disconnect the instrument from the main power source, and refer such maintenance to qualified service personnel.

Figure 4.1 Emergency Door Release

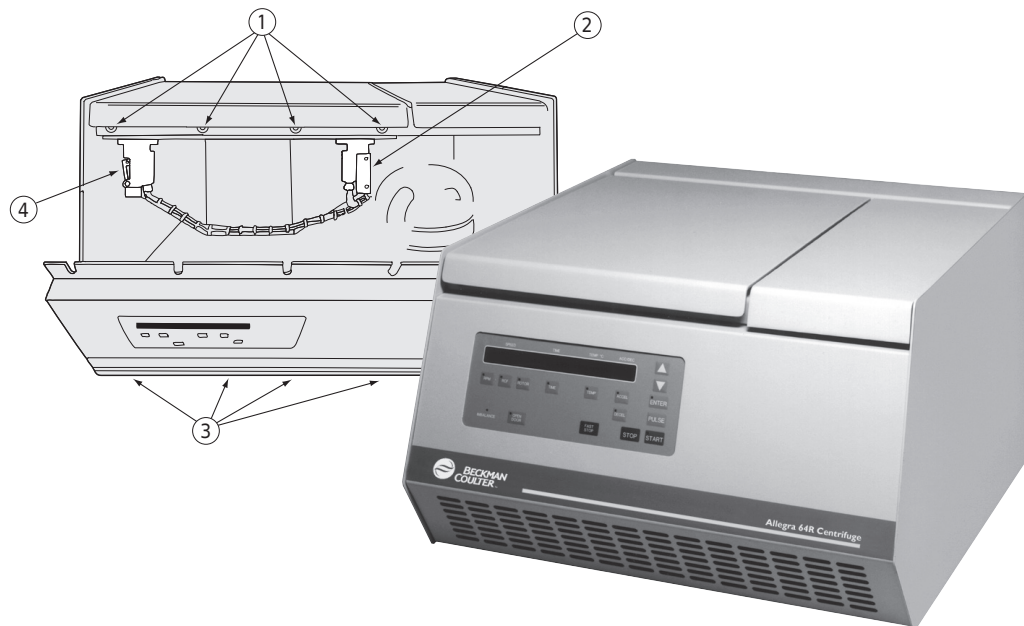

1. Use an Allen wrench to loosen four screws
2. Pull out (away from bowl) on latch release (behind guard plate)
3. Use an open-end wrench to remove four bolts (not visible from front)
4. Pull out (away from bowl) on latch-release

-
- 1 Turn the power switch to off (O) and disconnect the power cord from the main power source.

 **WARNING**

Never attempt to override the door interlock system while the rotor is spinning.

-
- 2 Make sure that the rotor is not spinning.
 - a. Do not proceed if there is any sound or vibration coming from the drive.
-
- 3 Use the 2.5-mm ball-head Allen wrench (964774) to loosen the four screws on the centrifuge front panel (see [Figure 4.1](#)).
-
- 4 Use a 7-mm open-end wrench to remove the bottom three bolts holding the front panel to the centrifuge.
-
- 5 Carefully lower the front panel to the bench top to expose the latch releases (see [Figure 4.1](#)).
-
- 6 Pull out (away from the bowl) on the latch releases until the latches “click” or the door pops open.
 - a. If the rotor is still spinning, close the door and wait until it stops before attempting to remove it.

 **WARNING**

Never try to slow or stop the rotor by hand.

- b. After removing the rotor, replace the front panel by following the instructions above, in reverse order.
-

Care and Maintenance

Introduction

For maintenance not covered in this manual, call Beckman Coulter Field Service. User messages are discussed in [CHAPTER 4, Troubleshooting](#). Refer to the applicable rotor manual and to Chemical Resistances (publication IN-175) for instructions on the care of rotors and their accessories.

NOTE It is your responsibility to decontaminate the centrifuge, as well as any rotors and accessories, before requesting service by Beckman Coulter Field Service.

 **WARNING**

Any maintenance procedure or servicing of this equipment that requires removal of any covers can expose parts which involve the risk of electric shock or personal injury. Make sure that the power switch is off (O) and the centrifuge is disconnected from the main power source, and refer such servicing to qualified service personnel.

Do not use alcohol or other flammable substances in or near operating centrifuges.

Maintenance

Preventive Maintenance

The following procedures should be performed regularly to ensure continued performance and long service life of the centrifuge.

- 1 Regularly inspect the interior of the rotor chamber for accumulations of sample, dust, or glass particles from broken sample tubes.
 - a. Clean as required (see [Cleaning](#), below), as these accumulations can result in rotor vibrations.
- 2 Regularly check the air intake and exhaust vents for obstructions.
 - a. Keep vents clear and clean.

3 Use a sponge to wipe condensation out of the chamber bowl between runs to prevent chamber icing.

4 If chamber icing occurs, defrost before use.

5 To prevent the rotor from sticking, lubricate the drive shaft with Spinkote at least once a month, and after each cleaning.

NOTE Before using any cleaning or decontamination methods except those recommended by the manufacturer, users should check with the manufacturer that the proposed method will not damage the equipment.

Cleaning

Frequent cleaning is recommended to prolong the life of the centrifuge.

1 *Always clean up spills when they occur to prevent corrosives or contaminants from drying on component surfaces.*

2 To prevent accumulations of sample, dust, and/or glass particles from broken sample tubes, keep the interior of the rotor chamber clean and dry by frequent wiping with a cloth or paper towel.

3 Clean the drive shaft, shaft cavity, threads, and the tie-down screw at least once a week using a mild detergent such as Beckman Solution 555™ and a soft brush.

- a. Dilute the detergent 10 to 1 with water.
- b. Rinse thoroughly and dry completely.
- c. Lubricate the drive shaft with Spinkote after cleaning.

4 Wash the bowl using a mild detergent such as Solution 555. Rinse thoroughly and dry completely.

- a. Rinse thoroughly and dry completely.

5 Clean the centrifuge case and door by wiping with a cloth dampened with Solution 555.

- a. Do not use acetone or other solvents.
-

Tube Breakage

If a glass tube breaks, and all the glass is not contained in the bucket or rotor, it will be necessary to thoroughly clean the interior of the chamber bowl.



Be careful when examining or cleaning the sealing gasket or chamber, as sharp glass fragments may be embedded in their surfaces.

- 1 Examine the gasket to make sure that no glass particles are retained in it.
 - a. Carefully remove any glass particles that may remain.
- 2 Carefully wipe away any glass particles that remain in the bowl.

Decontamination

If the instrument and/or accessories are contaminated with radioactive or pathogenic solutions, perform appropriate decontamination procedures. Refer to *Chemical Resistances* to be sure the decontamination method will not damage any part of the instrument.

Sterilization and Disinfection

The centrifuge is finished with urethane paint. Ethanol (70%)* may be used on this surface. See *Chemical Resistances* for more information regarding chemical resistance of centrifuge and accessory materials.

While Beckman Coulter has tested these methods and found that they do not damage the centrifuge, no guarantee of sterility or disinfection is expressed or implied. When sterilization or disinfection is a concern, consult your laboratory safety officer regarding proper methods to use.

* Flammability hazard. Do not use in or near operating centrifuges.

Storage and Transport

Storage

Before storing a centrifuge for an extended period, return it to its original shipping container to protect it from dust and dirt. Temperature and humidity conditions for storage should meet the environmental requirements described under *Specifications*.

Returning a Centrifuge

Before returning a centrifuge or accessory for any reason, prior permission (a Returned Goods Authorization form) must be obtained from Beckman Coulter, Inc. Contact your local Beckman Coulter office to obtain the RGA form and for packaging and shipping instructions.

To protect our personnel, it is the customer's responsibility to ensure that all parts are free from pathogens and/or radioactivity. Sterilization and decontamination must be done before returning the parts.

*All parts must be accompanied by a signed note, plainly visible on the outside of the box, stating that they are safe to handle and that they are not contaminated with pathogens or radioactivity. **Failure to attach this notification will result in return or disposal of the items without review of the reported problem.***

Supply List

NOTE Publications referenced in this manual can be obtained by calling Beckman Coulter at 1-800-742-2345 in the United States, or by contacting your local Beckman Coulter office.

Contact Beckman Coulter Sales (1-800-742-2345 in the United States) for information about ordering parts and supplies. For your convenience, a partial list is given below. See the Beckman Coulter *Benchtop Rotors, Tubes & Accessories* catalog (BR-9742, available at www.beckmancoulter.com) for detailed information on ordering rotors, tubes, and accessories. Refer to the rotor manual or materials and supplies needed for rotors.

Replacement Parts

Rotor tie-down screw	361367
T-handle wrench	361371
Anti-rotation kit	361377
Emergency latch-release tool (ball-head allen wrench)	964774

Supplies

NOTE For MSDS information, go to the Beckman Coulter website at www.beckmancoulter.com

Spinkote lubricant (2 oz)	306812
Silicone vacuum grease (1 oz)	335148
Beckman Solution 555 (1 qt)	339555

Beckman Coulter, Inc.

Allegra 64R, GS-15 Series, Allegra 21 Series, and Spinchron 15 Series Centrifuge Warranty

Subject to the exceptions and upon the conditions specified below and warranty clause of the Beckman Coulter, Inc. terms and conditions in effect at the time of sale, Beckman Coulter agrees to correct either by repair, or, at its election, by replacement, any defects of material or workmanship which develop within one (1) year after delivery of an Allegra 64R, Allegra 21, GS-15, or Spinchron 15 series centrifuge (the product), to the original buyer by Beckman Coulter or by an authorized representative, provided that investigation and factory inspection by Beckman Coulter discloses that such defect developed under normal and proper use.

Some components and accessories by their nature are not intended to and will not function for as long as one (1) year. A complete list of such components or accessories is maintained at the factory and at each Beckman Coulter District Sales Office. The lists applicable to the products sold hereunder shall be deemed to be part of this warranty. If any such component or accessory fails to give reasonable service for a reasonable period of time, Beckman Coulter will repair or, at its election, replace such component or accessory. What constitutes either reasonable service and a reasonable period of time shall be determined solely by Beckman Coulter.

Replacement

Any product claimed to be defective must, if requested by Beckman Coulter, be returned to the factory, transportation charges prepaid, and will be returned to buyer with the transportation charges collect unless the product is found to be defective, in which case Beckman Coulter will pay all transportation charges.

Except as specifically noted above, Beckman Coulter makes no warranty or representation, either expressed or implied, with respect to this software or its documentation including quality, performance, merchantability, or fitness for a particular purpose.

Conditions

Beckman Coulter shall be released from all obligations under all warranties, either expressed or implied, if the product(s) covered hereby are repaired or modified by persons other than its own authorized service personnel, unless such repair in the sole opinion of Beckman Coulter is minor, or unless such modification is merely the installation of a new Beckman Coulter plug-in component for such product(s).

Disclaimer

IT IS EXPRESSLY AGREED THAT THE ABOVE WARRANTY SHALL BE IN LIEU OF ALL WARRANTIES OF FITNESS AND OF THE WARRANTY OF MERCHANTABILITY AND THAT NEITHER BECKMAN COULTER, INC. NOR ITS SUPPLIERS SHALL HAVE ANY LIABILITY FOR SPECIAL OR CONSEQUENTIAL DAMAGES OF ANY KIND WHATSOEVER ARISING OUT OF THE MANUFACTURE, USE, SALE, HANDLING, REPAIR, MAINTENANCE, OR REPLACEMENT OF THE PRODUCT.

Symbol Symbol Symbole Símbolo	Simbolo 記号 符号	Title / Titel / Titre / Titolo / Titolo / 名称 / 名称
		Dangerous voltage Gefährliche elektrische Spannung Courant haute tension Voltaje peligroso Pericolo: alta tensione 危険電圧 危险电压
		Attention, consult accompanying documents Achtung! Begleitpapiere beachten! Attention, consulter les documents joints Atención, consulte los documentos adjuntos Attenzione: consultare le informazioni allegate 注意、添付資料を参照のこと 注意，请参阅附带的文件
		On (power) Ein (Netzverbindung) Marche (mise sous tension) Encendido Acceso (sotto tensione) 入（電源） 开（电源）
		Off (power) Aus (Netzverbindung) Arrêt (mise hors tension) Apagado Spento (fuori tensione) 切（電源） 关（电源）
		Protective earth (ground) Schutzleiteranschluß Liaison à la terre Puesta a tierra de protección Collegamento di protezione a terra 保護アース（接地） 保护接地
		Earth (ground) Erde Terre Tierra Scarica a terra アース（接地） 接地

www.beckmancoulter.com

